

RD151

Toyota 8" IFS,34 SPL

PARTS LIST

ITEM #	QTY	DESCRIPTION	PART #	NOTES
1	1	FLANGE CAP KIT	027341SP	
2	1	BONDED SEAL	160703SP	
3	1	CLUTCH GEAR & WAVESPRING KIT	050904SP	5
4	1	WAVESPRING	150704SP	
5	1	LONG CROSS SHAFT	060204SP	
6	1	SPIDER BLOCK	070201SP	
7	1	SIDE GEAR	SEE NOTE	3
8	1	RETAINING PIN SET (PK OF 4)	120601SP	
9	2	BEARING RETAINING SLEEVE	190104SP	
10	1	3mm MASTER SHIM	150356	
11	1	MASTER SHIM	150305	
12	1	SHIM KIT	SHK009	
13	1	SEAL HOUSING KIT	081805SP	
14	1	SEAL HOUSING O-RINGS (PK OF 2)	160207-2	1
15	2	TAPERED ROLLER BEARING	160119	2
16	2	ANTI-FRICTION BUSHING (PTFE)	160805SP	
17	1	SPLINED SIDE GEAR	SEE NOTE	3
18	4	PINION THRUST WASHER	SEE NOTE	4
19	4	PINION GEAR	SEE NOTE	3
20	2	SHORT CROSS SHAFT	060403SP	
21	2	SIDE GEAR THRUST WASHER	SEE NOTE	4
22	1	DIFFERENTIAL CASE	013041SP	
23	1	COUNTERSUNK SCREW (PK OF 2)	200213SP	
*	1	BULKHEAD FITTING KIT (BANJO TYPE)	170114	6
*	1	AIR LINIE (6mm DIA X 6m LONG)	170314	6
*	1	SOLENOID VALVE (12V)	180103	
*	1	SWITCH FR LOCKER	180223	
*	1	CABLE TIE (PK OF 25)	180305	
*	1	OPERATING & SERVICE MANUAL	210200	
*	1	INSTALLATION GUIDE	2102151	

* *Not illustrated in exploded view*

NOTES

- 1 For replacement O-rings use only BS136 Viton 75.
- 2 For replacement bearings use ARB #160119 (Toyota Aust #90366T0031, Koyo STA5383)
- 3 Available only as complete 6 gear set #728H191
- 4 Available only as complete thrust washer kit #730H01
- 5 Always bench test both engagement and disengagement of the clutch gear before reinstalling *Air Locker* into the vehicle.
- 6 All diffs produced before serial #17070001 came with 5mm air connection system. For information contact ARB.
- Spare axle retaining clips may be required (not supplied) to refit CV shafts.
- Spare axle shaft oil seal may be required (not supplied – Toyota Aust #9031147012)
- For 8" IFS with 50mm carrier bearings refer to RD131 ([Section 2.131](#)).
- For 8" IFS with 53mm carrier bearings and cast iron housing, refer to RD111 ([Section 2.111](#)) or RD121 ([Section 2.121](#)).

RD151

Toyota 8" IFS,34 SPL

EXPLODED DIAGRAM

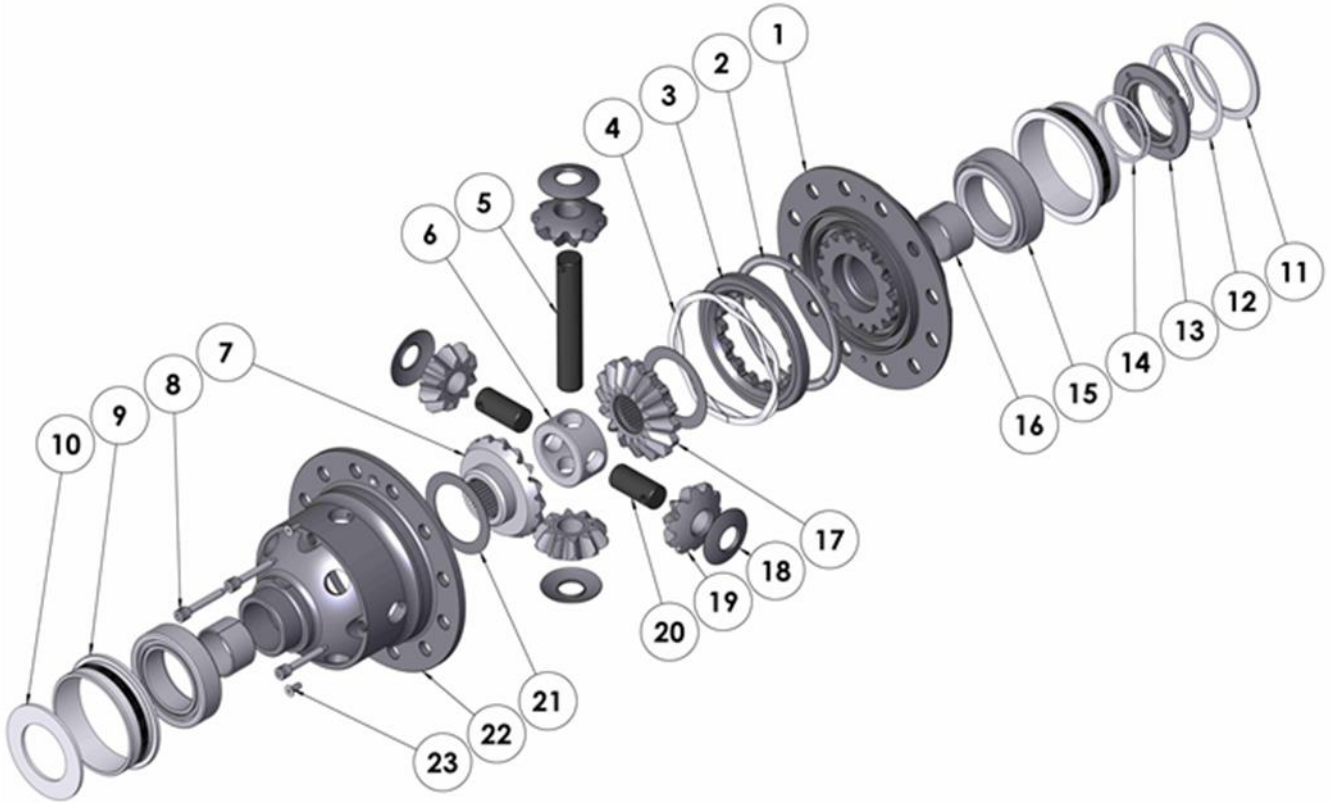

SPECIFICATIONS

Axle Spline	34 tooth, Ø34.9mm [1.37"]
Ratio Supported	All
Ring Gear ID	134.0mm [5.28"]
Ring Gear OD	200mm [8"]
Ring Gear Bolts	12 bolts on Ø160mm [6.30"]
Ring Gear Torque	135Nm [100 ft-lb]
Backlash	0.15-0.25mm [0.006-0.010"]

ARB Corporation Ltd ▪ 42-44 Garden St Kilsyth VIC 3137 Australia
ARB 4X4 Accessories USA ▪ 4810 D St. NW #103 Auburn WA 98001 USA
Australia & International Customer Service ▪ +61 3 9761 6622
North America Customer Service ▪ Toll Free 866 293 9078
www.arb.com.au (AUS & Int) www.arbusa.com (N. America)

