





# OUTBACK SOLUTIONS

Modular Roller Drawer Systems by ARB

Part No.	Description	Part No.	Description
RD1355	Roller Drawer	RDRF1045	Roller Drawer with Roller Floor
RD1045	Roller Drawer	RDRF94	Roller Drawer with Roller floor
RD945	Roller Drawer	RF1355	Roller Floor
RD845	Roller Drawer	RF1045	Roller Floor
RD745	Roller Drawer	RF945	Roller Floor
RDRF1355	Roller Drawer with Roller Floor		
			
Roller Drawer		Roller Drawer With Roller Floor	
			
		Roller Floor	

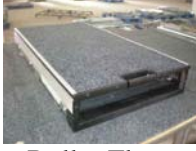
**HAVE AVAILABLE THESE SAFETY ITEMS WHEN FITTING PRODUCT:**

Protective eyewear		Hearing protection	
--------------------	---	--------------------	---

**HAVE AVAILABLE THESE TOOLS FOR FITMENT OF PRODUCT:**

Metric socket and spanner sets 6-17mm range	Tape Measure
Screwdrivers, Philips and Flat blade	Marking pen
Short Body Power Drill 13mm (1/2") capacity	12mm, 10mm, 6mm & 4mm drill bits
Metric 4mm hex key	Stanley knife
Hammer	Fine Flat File

*NOTE: 'WARNING' notes in the fitting procedure relate to OHS situations, where to avoid a potentially hazardous situation it is suggested that protective safety gear be worn or a safe work procedure be employed. If these notes and warnings are not heeded, injury may result.*

FASTENER TORQUE SETTINGS:

SIZE	Torque Nm	Torque lb ft
M6	9Nm	4lbft
M8	22Nm	16lbft
M10	44Nm	32lbft
M12	77Nm	57lbft

These instructions are designed to assist in the installation of the above products. Due to the wide application of Outback Solutions Modular Drawers, not all sections of this instruction will apply to all installations. Please read all sections prior to deciding on the sections most applicable to your requirements.

# Contents

General Care and Maintenance:.....	3
Operation.....	3
SECTION 1. General Instructions:.....	4
SECTION 2. Hat Mount detail drawings:.....	11
SECTION 3. Spacer Thicknesses and Sizes:.....	17
SECTION 4. 1355 SERIES INSTALLATION INSTRUCTIONS:.....	18
75/ 78 SERIES LANDCRUISER TROOP CARRIER: 06/85...on. ....	18
TOYTA HILUX: 11/97 - 2004. ....	18
TOYOTA HILUX: 02/05...on. ....	18
NISSAN NAVARA D22: 04/97 - 10/05. ....	18
NISSAN NAVARA D40-STX & RX: 11/05...on. ....	18
MITSUBISHI TRITON MK: 10/96 - 07/06.....	18
MITSUBISHI TRITON ML: 8/06 - 9/09. ....	18
MITSUBISHI TRITON MN: 10/09...on. ....	18
HOLDEN RODEO: 1988 - 11/02.....	18
HOLDEN COLORADO: 12/02...on.....	18
ISUSU RODEO: 12/02...on. ....	18
ISUSU D-MAX 2009...on. ....	18
GREAT WALL 2009...on.....	18
MAZDA/ COURIER B2600: 1999- 2007. ....	18
MAZDA BT-50: 2007...on. ....	18
FORD RANGER: 2006...on. ....	18
SECTION 5. 1045 SERIES INSTALLATION INSTRUCTIONS:.....	20
200 SERIES LANDCRUISER 12/07...0N. ....	20
100 SERIES LANDCRUISER 04/98...11/07.....	20
80 SERIES LANDCRUISER... 01/95 - 03/98.....	20
NISSAN PATROL GU 11/97...on.....	20
SECTION 6. 945 SERIES INSTALLATION INSTRUCTIONS:.....	24
76SERIES LANDCRUISER WAGON .....	24
TOYOTA LANDCRUISER PRADO 120 1/05 TO 10/09.....	24
SECTION 7. Assembly and Finishing Off. ....	26
SECTION 8. Stacker Drawer installation. ....	27
SECTION 9. Single and Custom Installation. ....	28

## NOTE THE FOLLOWING:

# WARNING

### Installation

- ◆ This product must be installed as per these instructions.
- ◆ Use only hand held tools for installation, electric or air tools may damage screw heads, cross threads or slip and damage interior of the vehicle.
- ◆ It is recommended that trained personnel install this product.
- ◆ These instructions are correct as at publication. Outback Interiors Ltd. cannot be held responsible for the impact of any changes subsequently made by the vehicle manufacturer.
- ◆ Some installations will require marking and drilling of bolt holes. Please use safe power tool practices, double check measurements prior to drilling and ensure clearance under the drilling surface.
- ◆ During installation, it is the duty of the installer to check correct operation/clearances of all components. eg: tail gate, doors, etc
- ◆ Work safely at all times

### Operation

- ◆ Drawers and Roller Floors should only be opened / operated on level ground.
- ◆ Always use Slam Latch handles to open and close Drawers or Roller Floors.
- ◆ Remove the key from the slam shut handles lock before closing the vehicles tailgate or rear doors to avoid damage to the key and the vehicles interior.
- ◆ A Cargo Barrier should be installed where possible to provide occupant protection.
- ◆ Drawer contents should be spread evenly throughout the drawer and not exceed 100Kg.
- ◆ Top floor and Roller floor loads should be spread evenly across the floor and not exceed 75Kg.

## General Care and Maintenance:

- ◆ Using a clean rag, wipe and clean off excess grease from bearings and drawer rails  
**Note:** do not use degreasers or cleaning fluids when cleaning bearings and rails.
- ◆ Every three months, spray a small amount of CRC (or similar) onto Drawer and Roller Floor Runners. Operate Drawer or Roller floor several times, then wipe the runners clean with a rag to remove built up dust and dirt from bearings. Maintenance should be carried out more regularly in harsh or dusty environments.
- ◆ Dirt or mud on the carpet surfaces should be allowed to dry. Once dry use a stiff brush to loosen the dirt and then vacuum.
- ◆ Light dust can be brushed off or vacuumed.
- ◆ The drawer materials are water resistant, however if liquid is spilt onto or into a drawer or roller floor, it should be immediately dried.

## Operation:

- ◆ To open Drawer or Roller Floor:  
Ensure key lock is not locked and pull the Grab Handle on the Slam Latch.
- ◆ Outback solutions modules feature an Anti Roll Back mechanism. Pulling the Drawer or Roller Floor out to full extension locks the system open.



The Drawer will now resist a closing force of 14kg. A knock with the palm of your hand against the carpet drawer front adjacent to the latch, disengages the anti roll back mechanism and allows the Drawer or Roller Floor to roll shut.

- ◆ To Close Drawer or Roller Floor:  
Drawers and Roller Floors use a slam shut latch. Push the Drawer or Roller Floor shut by the Grab Handle with a moderate force and the latch will shut in place.
- ◆ Drawer slam latches are able to lock by using the supplied keys. Roller Floor slam latches are lockable by turning the Locking Knob located under Roller Floor slam latch. For security key lock the drawer latch.
- ◆ Remove the key from the slam shut handle's lock before closing the vehicles tailgate or rear doors to avoid damage to the key and the vehicles interior.

Roller floor unlocked.









Roller floor locked.



## SECTION 1. General Instructions:

**READ AND UNDERSTAND ALL INSTRUCTIONS BEFORE INSTALLING IN VEHICLE.**

<p><b>Note:</b></p>	
<ul style="list-style-type: none"> <li>◆ <b>Front</b> refers to <b>front</b> of the vehicle and <b>Rear</b> refers to rear of <b>rear</b> of the vehicle.</li> <li>◆ Fittings kits are supplied with each module. When bolting two modules together use fittings supplied in each module. Leftover parts are for use in installations to different vehicles.</li> </ul>	
<p><b>Unpacking Carton; Removing Module:</b></p>	<p>Cardboard packaging is recyclable. </p>
<p>1. Cut away strapping from carton.</p>	
<p>2. Prise both ends out of carton.</p>	

<p>3. Grasp and slide module out.</p>	
<p>4. Cut/remove internal packing from module.</p>	
<p><b>Installation Preparation:</b></p>	
<p><b>5. FIXED FLOOR REMOVAL.</b>  Using a 4mm Allen key, remove Fixed Floor from frame by removing the countersunk setscrews from both sides of floor.  This provides access to marking, fixing, joining and/or drilling locations of framework for installation.</p>  <p>Modules with a Roller Floor do not need Roller Floor removing. Rolling the floor out to full extension provides access to marking, fixing, joining and/or drilling locations.</p>	
<p><b>6. ROLLER FLOOR TRAY REMOVAL.</b>  To open Roller Floor grasp Grab Handle and pull backwards.  To remove roller floor tray open Roller Floor slightly and remove tray end stops from <b>front</b> of tray. Slide tray out and remove from sliding track.  To Open Roller Floor grasp Grab Handle and pull backwards</p>  <p>Tray will not disengage from sliding track until tray end stops are removed</p>	

**7. DRAWER REMOVAL**

Working from inside the drawer use a 10mm socket and ratchet, or Philips head screwdriver to remove the four (4) “anti rattle” Drawer Stop fastening bolts and washers at the front of drawer.

Roll drawer out clear of framework, drawer stops will fall free.

Use a clean rag wipe to clean off access shipping grease from bearings and drawer rails.



Retain all stops, bolts and washers for reinstallation; ensure 6mm flat washers are retained under bolt heads for reinstallation.



Do not use degreaser or cleaning fluids when cleaning bearings and rails.



**8. FASTENING MODULES TOGETHER.**

If two or more modules are to be installed side by side, their frames must be attached together.

Set frames side by side on a covered workbench. Frames should sit in their correct orientation with the hat sections on the bottom.



**9. DRAWER MODULE to DRAWER MODULE.**

Use fittings from both module fit kits. Using six (6) 6mm x 20mm bolts, twelve (12) flat washers and six (6) nylock nuts, bolt through the six (6) sets of 6mm holes along top and bottom sides of bearing channels.



Use 6mm flat washers under the heads of the bolts and the nyloc nuts.

The six (6) sets of 6mm holes in the frame have two (2) plastic nipples protruding on either side.

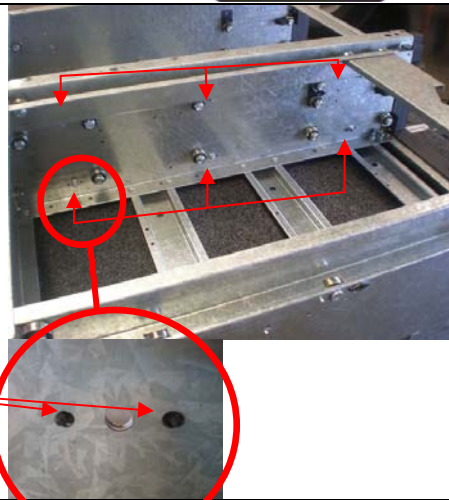

**10. DRAWER MODULE to ROLLER FLOOR & ROLLER FLOOR to ROLLER FLOOR.**

Lay frames side by side on a covered workbench.

Using three (3) 6mm x 20mm bolts, three (3) flat washers on both sides of framework and three (3) nylock nuts bolt through the three (3) sets of 6mm holes top and bottom of Bearing Channels.



The three (3) sets of 6mm holes in the frame have two (2) plastic nipples protruding on either side



**11. RELOCATING HAT SECTIONS.**

It may be necessary to relocate the lower mounting hat sections attached to the underside of the frame. Look up the hat section measurements for your vehicle, Refer **Section 2... Hat Mount Details** for vehicle specific models. You will require the measurement for both the front and the rear hat sections.

12. Once you have correct hat section measurement for your vehicle, use a tape measure and measure from the **outer** edge of the plastic trim. Using a marking pen, mark along the bearing channels.



Photograph shows a double installation. Hat sections have been removed in the photograph for clarity.

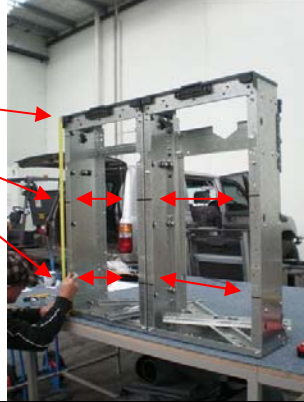

13. Using a ratchet, 10mm socket and 10mm ring spanner, remove the hat sections. Relocate the hat sections so centre of the hat section is over positions marked in step 12. Holes are provided in the frame for re mounting.



Centre of hat sections **must** correspond with pen marks.

Ensure bolts heads are **inside** and nuts are **outside** of framework.



14. Using a hammer knock the “C” section Joiner Channels into the hat sections until both sides of the joiner protrudes evenly into each frame.

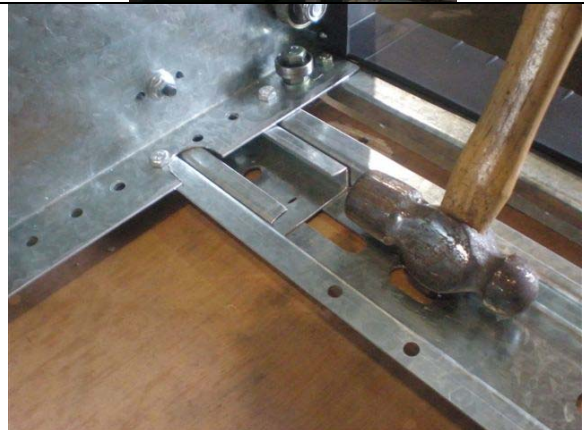

**15. FRAME INSTALLATION FOR SINGLE DOUBLE AND MULTIPLE MODULES NOT INCLUDED IN THIS SECTION:**



Instructions in this section are for double modules. Double modules have fixing points on the left side of one module and right side of the other. When installing a single module, double or multiple modules to a vehicle not included in this section refer to **Section 9 for Single and Custom Installations.**



Single modules must be fastened down using four (4) spacer blocks and four (4) 10mm bolts. Care must be taken when selecting fixing locations on the vehicle.



The installer must confirm suitable locations for bolting through the floor. Confirm all measurements and ensure clearance underneath before drilling any holes.

16. Using marking pen, mark the positions of mounting holes on the **front** and **rear** hat sections. Refer **Section 2...Hat Mount Details** for vehicle specific measurements.



The following steps in this section should be read in conjunction with the section relating to your modules series and vehicle. Refer page 2; **Sections 4, 5 or 6.** Read your particular section before proceeding.

**18. Decorative trim strip removal:**  
To find if decorative trim strip removal is required for your vehicle installation refer **Section 3...Spacer Thickness and sizes.**



Do not remove decorative trim unless specified in **Section 3...Spacer Thickness and Sizes.**



19. If decorative trim strip requires removal bend strip back and forth to weaken plastic then cut off from rear of frame using a trim knife with new blade.



Do not remove decorative trim unless specified. Refer **Section 3...Spacer Thicknesses and Sizes.**



20. Lightly file at slight angle.



21. Carefully file around and down to remove white strands of plastic.



22. Some spacers need joiner pins cut away from **last** spacer on stack and removed for installation as shown.



23. Assemble spacer blocks by stacking and knocking together. Fasten spacer blocks to module by knocking onto each parent spacer attached to **rear** underside corners of framework. Refer **Section 3... Spacer Thicknesses and Sizes** for vehicle specific sizes.



Failure to install spacer blocks to parent spacers on underside of framework where applicable will result in framework “flexing” and **void warranty.** Refer **Section 3...Spacer thickness and sizes; whether applicable to your particular vehicle.**



**Do not** remove joiner pins from last of these spacers.

24. Fasten Spacer Blocks to underside of Latch Lock sill insert. Refer **Section 3... for vehicle specific sizes.**



**Remove** joiner pins from last of these spacers.



25. Using a marking pen place a mark in the top of hat sections A and B where the mounting bolts will pass through.



Refer **Section 2...Hat Mount Details** for vehicle specific measurements.

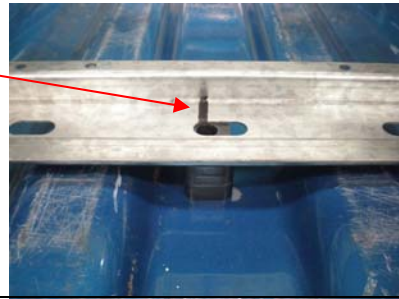

26. Assemble spacer blocks for under marked holes made on hat sections A and B in step 25. Refer **Section 3... Spacer Thicknesses and Sizes** for vehicle specific spacer sizes.

Spacer blocks to be central of floor ribs or over vacant bolt holes.

When installed, position pen marks on hat sections central to holes in spacer blocks.



If installing a module with a Roller Floor, roll floor out to fully extended position; rolling floor out to full extension provides access for fixing, marking and drilling locations.

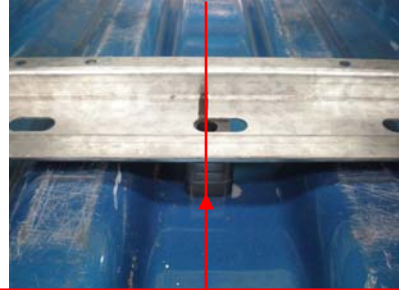

- Spacer blocks centre of floor ribs or over vacant bolt holes.
- Pen marks centre to holes in Spacer Blocks

# SECTION 2. Hat Mount detail drawings:

## 945 SERIES HAT SECTION MOUNTING DETAILS

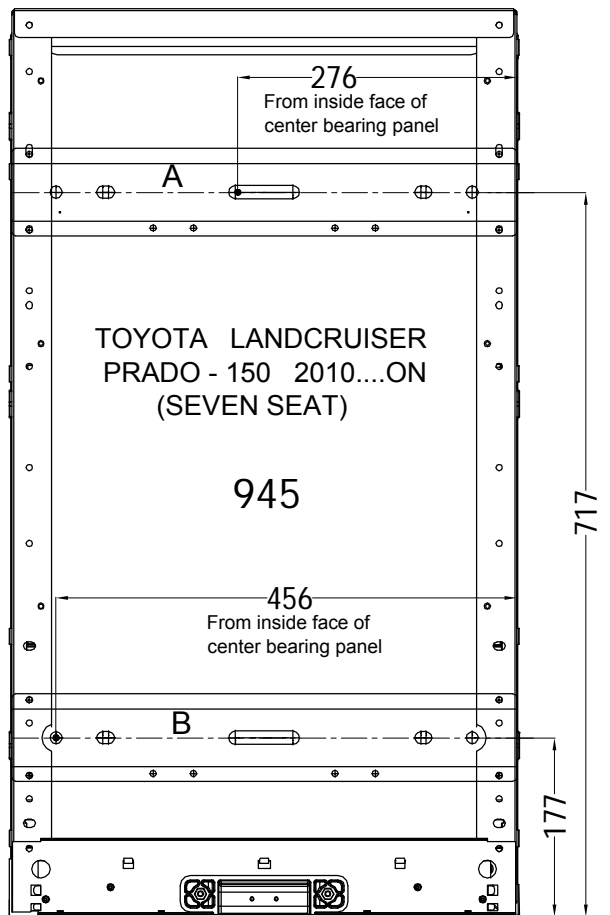
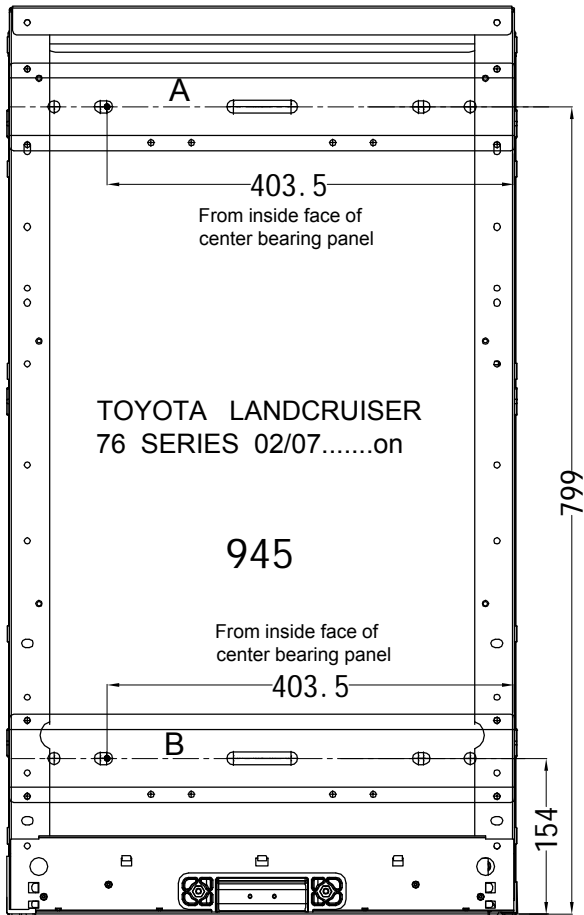
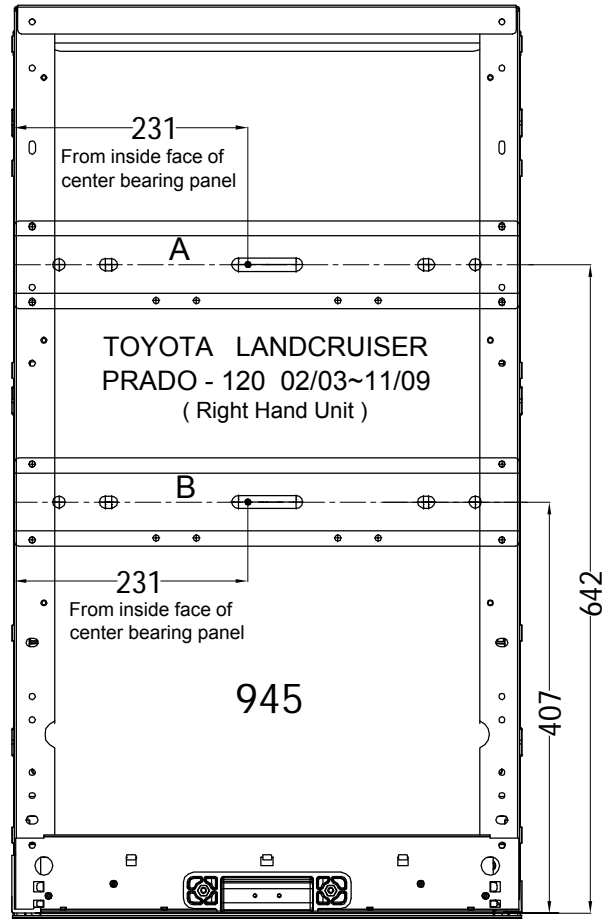
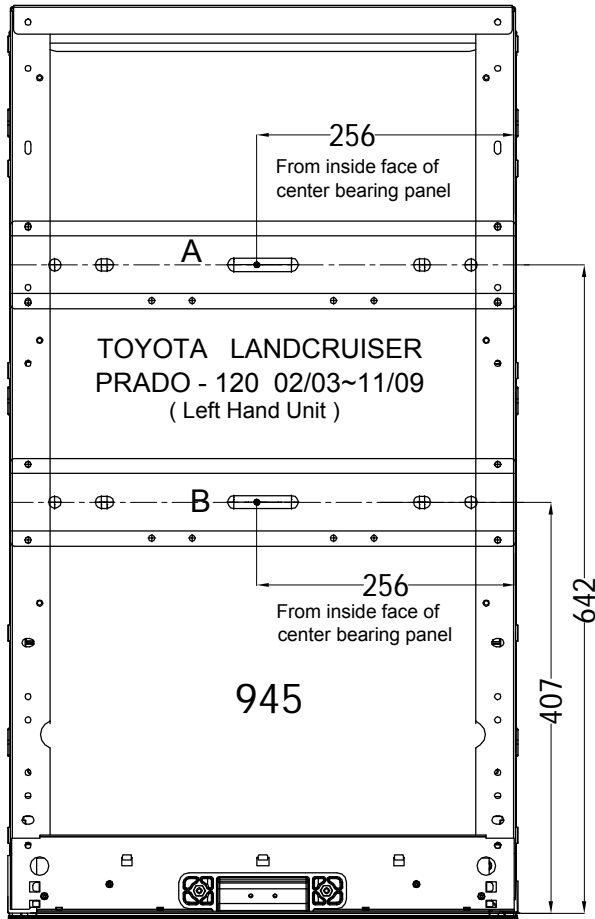

# 1045 SERIES HAT SECTION MOUNTING DETAILS

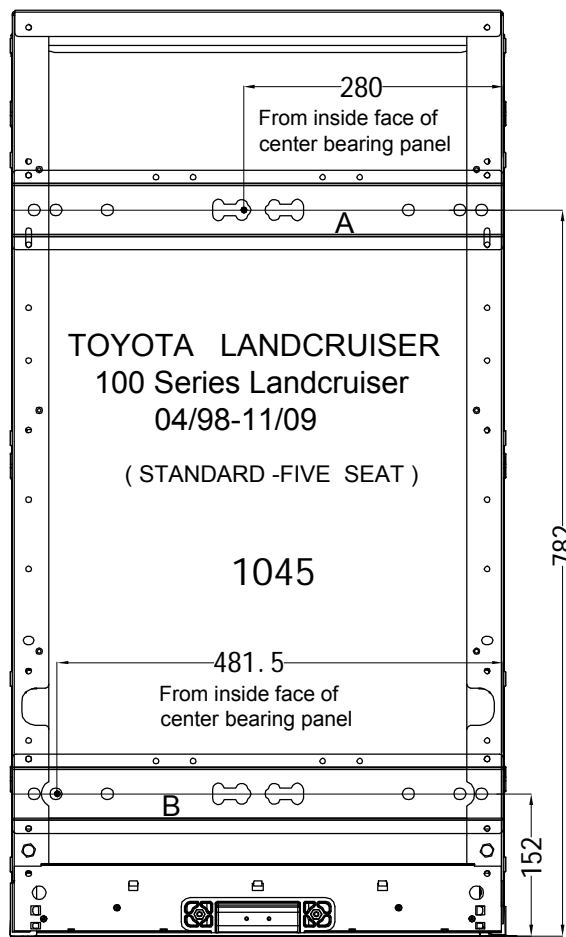
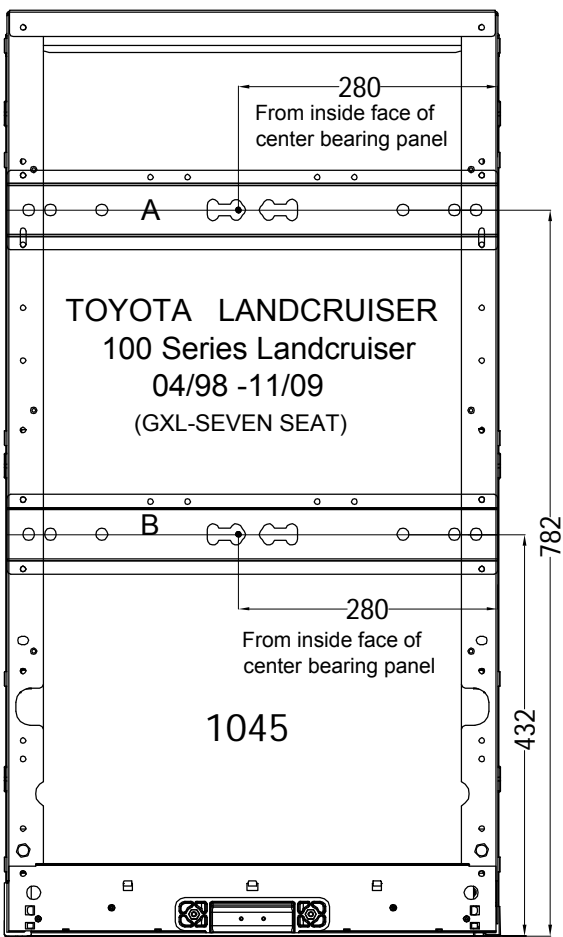
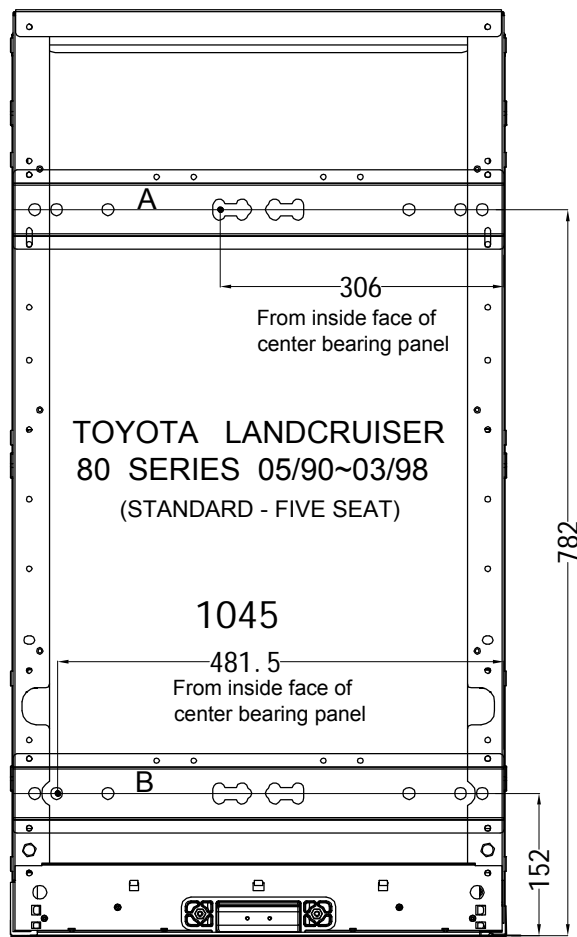
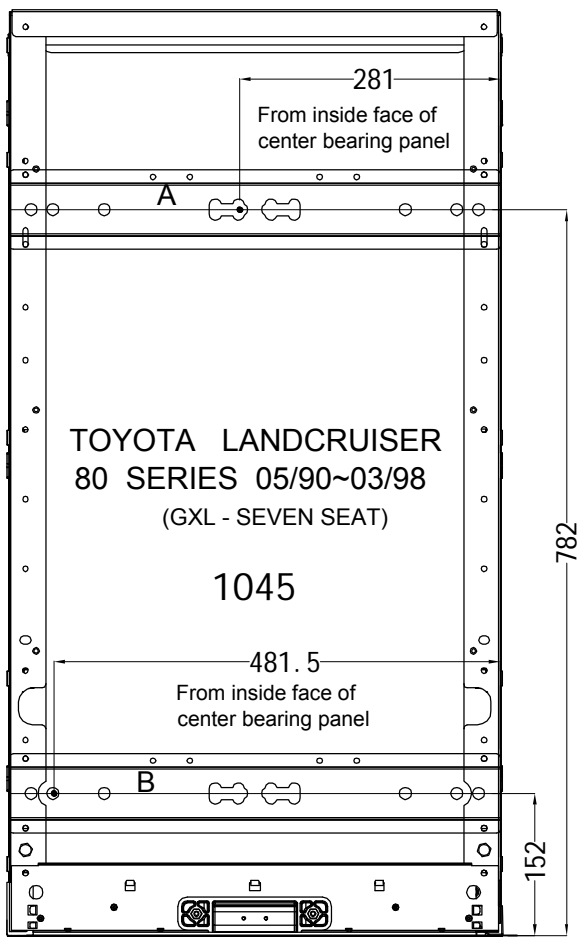

# 1045 SERIES HAT SECTION MOUNTING DETAILS

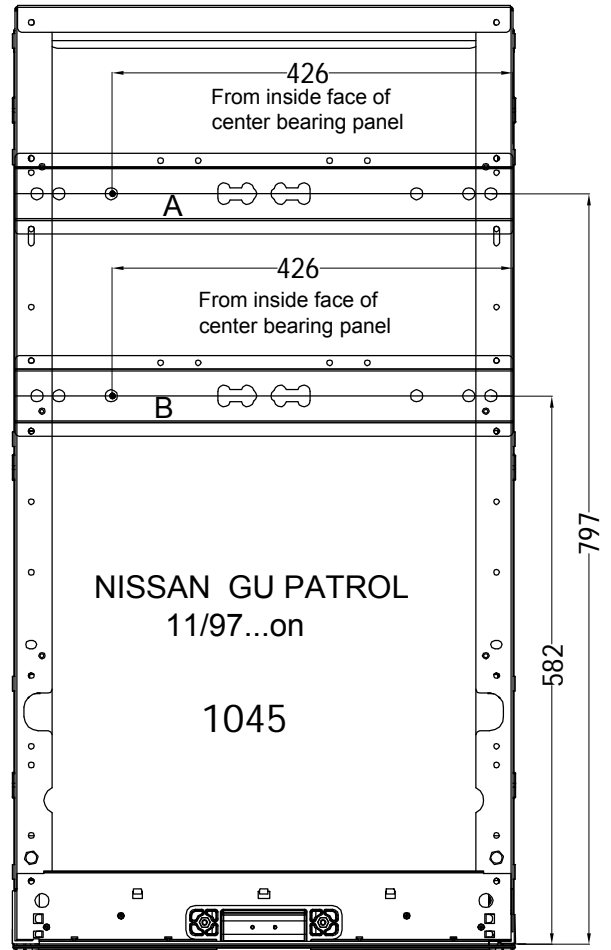
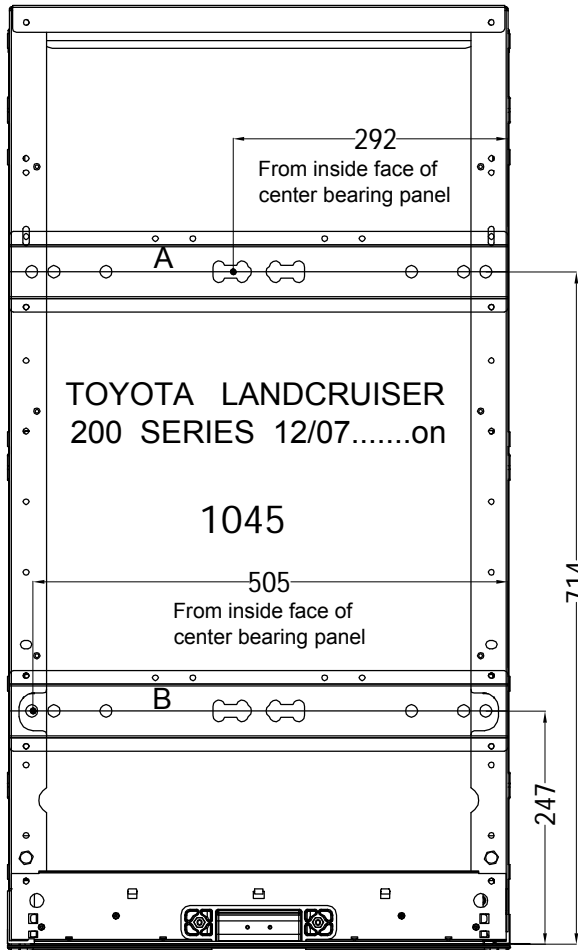

# 1355 SERIES HAT SECTION MOUNTING DETAILS

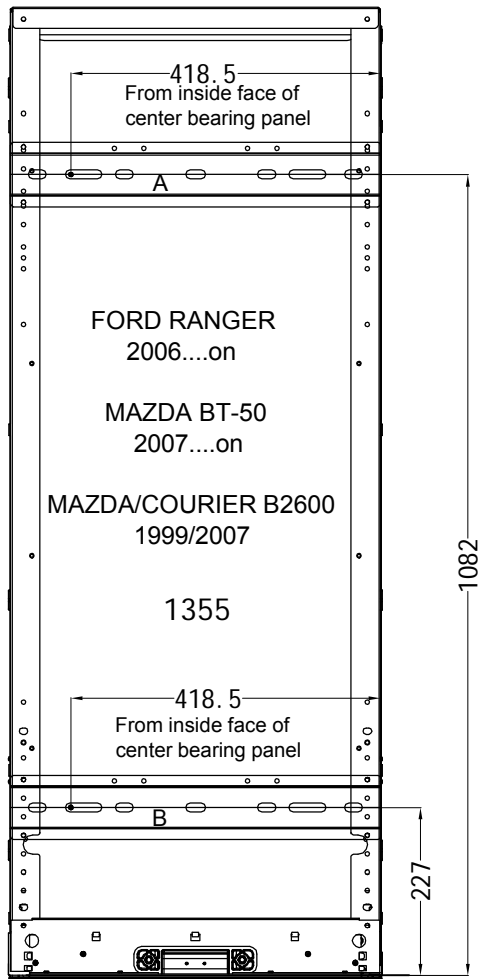
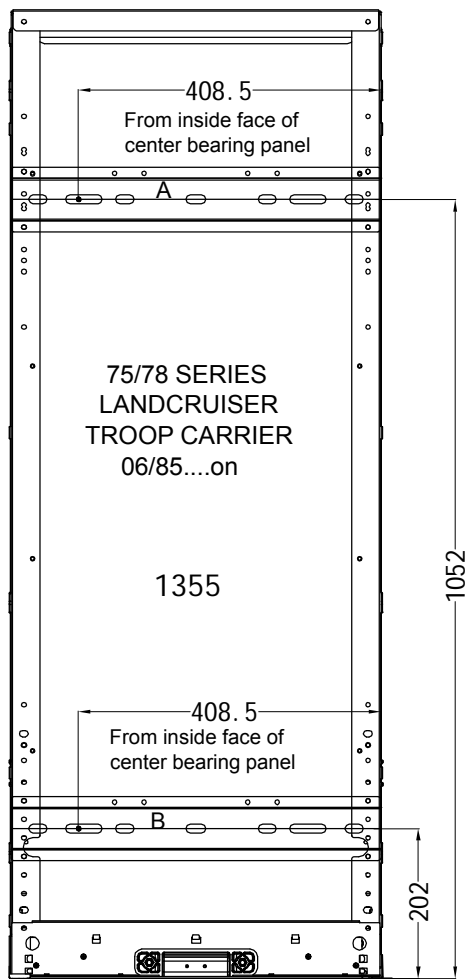
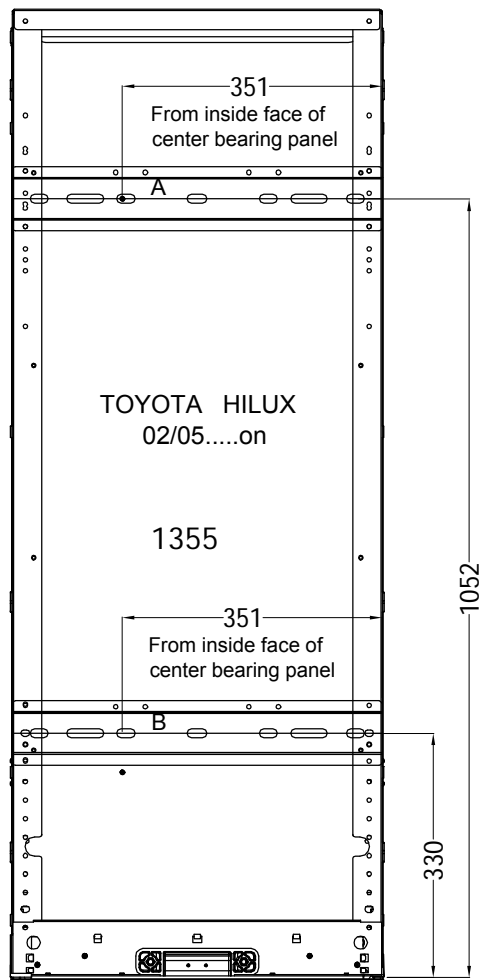
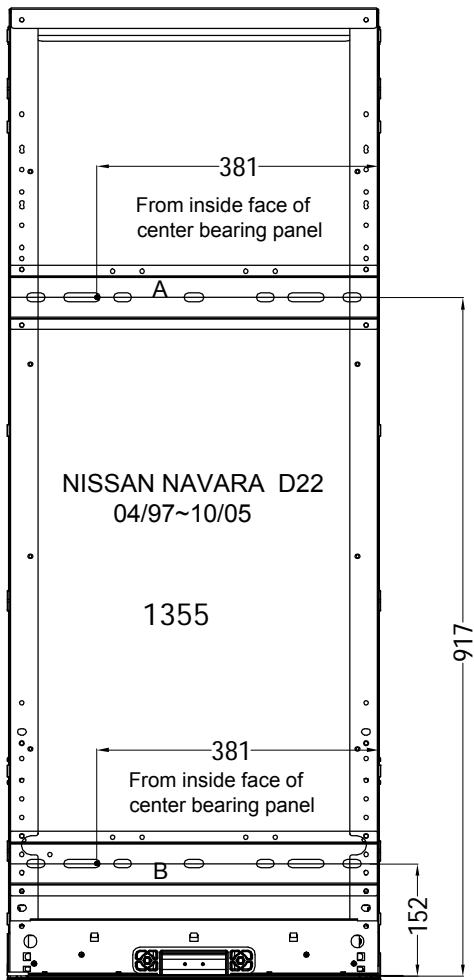

# 1355 SERIES HAT SECTION MOUNTING DETAILS

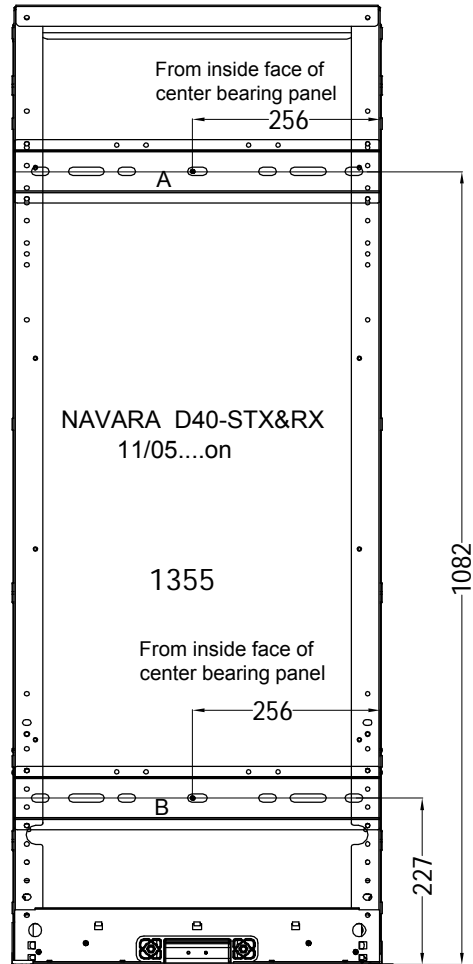
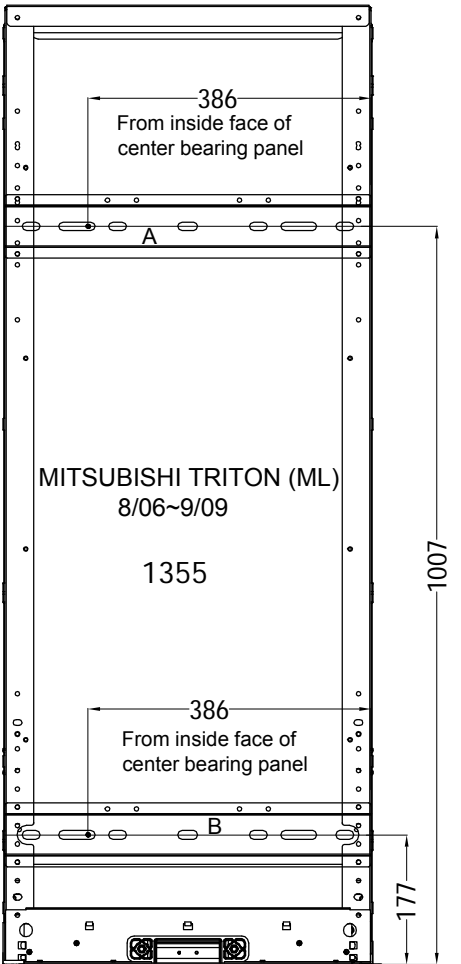
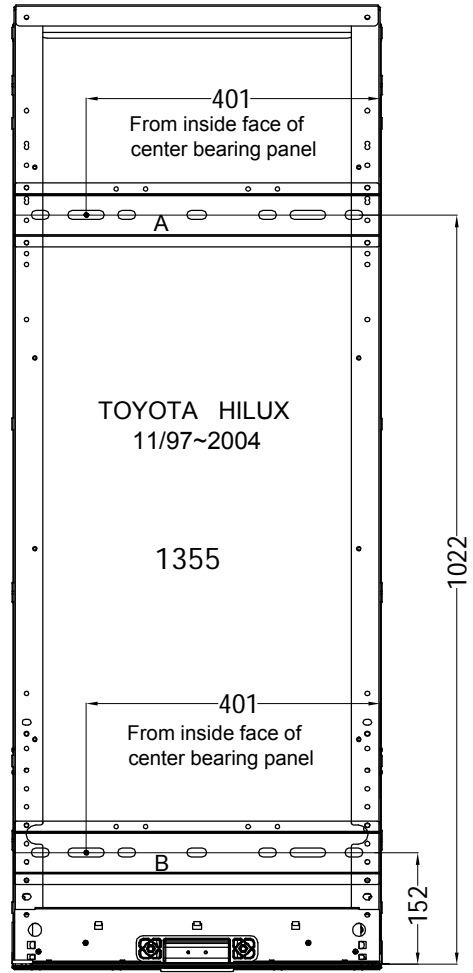
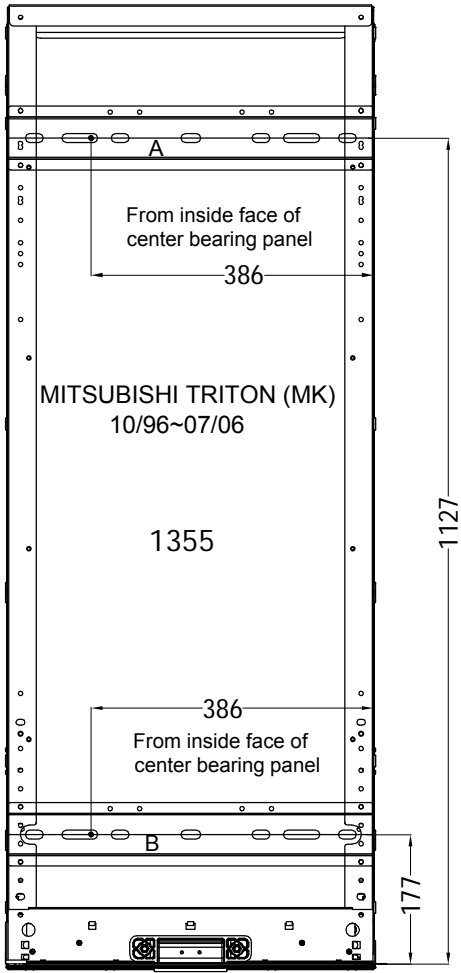

# 1355 SERIES HAT SECTION MOUNTING DETAILS

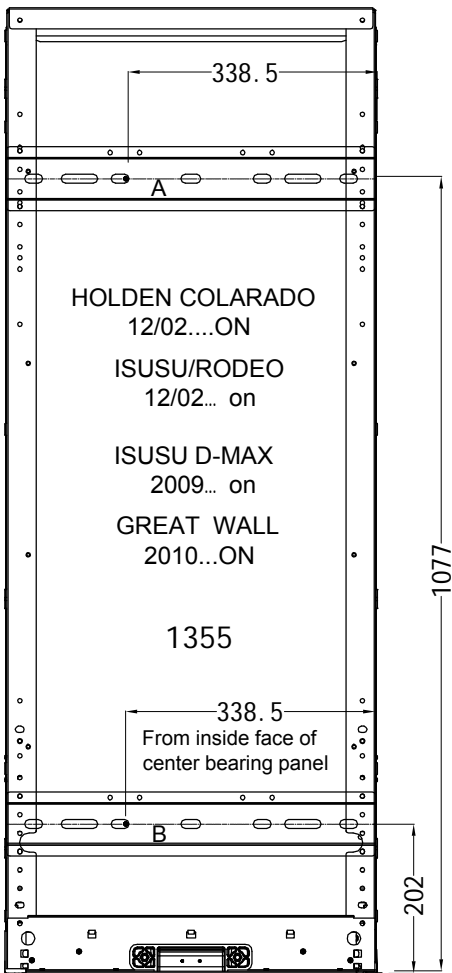
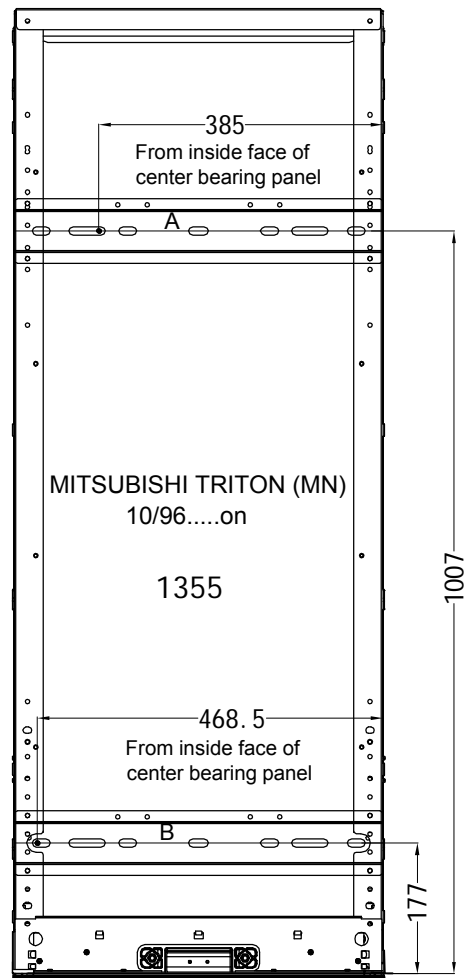
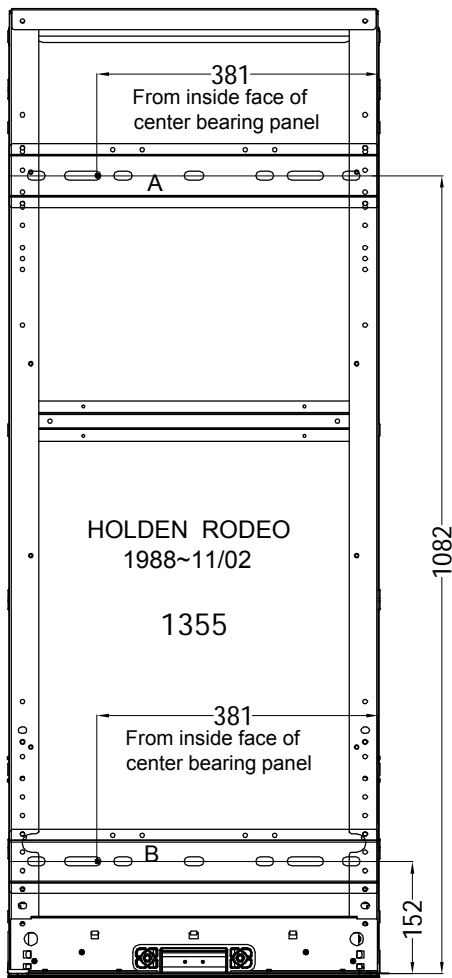



## SECTION 3. Spacer Thicknesses and Sizes:

MODULAR SERIES AND VEHICLE MODEL:	VEHICLE SPECIFIC MEASUREMENTS. LOCATE MODULES FROM REAR OF VEHICLE.	PLACE UNDER HAT SECTION "A"	PLACE UNDER HAT SECTION "B"	CLIP AND ATTACH ON REAR UNDERSIDE CORNERS OF FRAMEWORK	CLIP AND ATTACH ON UNDERSIDE OF LATCH LOCK INSERT	REMOVE DECORATIVE EDGE STRIP
		REMOVE pins from last of these spacers	REMOVE pins from last of these spacers	DO NOT remove pins from last of these spacers	REMOVE pins from last of these spacers	YES/NO
<b>1355 SERIES:</b>						
TOYOTA HILUX 2005... ON	390mm from tail gate	2- 15MM (2 -1x10mm 1x5mm)	2- 15MM (2 -1x10mm 1x5mm)	4- 6MM (4 - 1x6mm)	2- 6MM (2 - 1x6mm)	YES
TOYOTA HILUX 11/97 TO 12/04	190mm from tail gate	2- 12MM (2 - 2x6mm)	2- 12MM (2 - 2x6mm)	4- 6MM (4 - 1x6mm)	2- 6MM (2 - 1x6mm)	YES
NISSAN NAVARA D40 STX(Spanish Tub) 09/05...ON	290mm from tail gate	2- 20MM (2 - 10mm)	2- 20MM (2 - 10mm)	4- 18MM (4 - 3x6mm)	2- 12MM (2 - 2 x 6mm)	NO
NISSAN NAVARA D40 DX(Thai Tub) 09/05...ON	290mm from tail gate	2- 15MM (2 -1x10mm 1x5mm)	2- 15MM (2 -1x10mm 1x5mm)	4- 15MM (4 -1x10mm 1x5mm)	2- 12MM (2 - 2 x 6mm)	NO
NISSAN NAVARA D22: 04/97 - 10/05	195mm from tail gate	2- 15MM (2 -1x10mm 1x5mm)	2- 15MM (2 -1x10mm 1x5mm)	4- 15MM (4 -1x10mm 1x5mm)	2- 12MM (2 - 2 x 6mm)	YES
HOLDEN RODEO & COLORADO 12/02...ON	245mm from tail gate	2- 15MM (2 -1x10mm 1x5mm)	2- 15MM (2 -1x10mm 1x5mm)	4- 16MM (4 - 1X6mm 1x10mm)	2- 20MM (2 - 2x10mm)	YES
RODEO DUAL CAB 1988 – 11/02	195mm from tail gate	2- 12MM (2 - 2x6mm)	2- 12MM (2 - 2x6mm)	4- 12MM (4 - 2X6MM)	2- 6MM (2 - 1x6mm)	YES
ISUZU D-MAX DUAL CAB 2009...ON	195mm from tail gate	2- 12MM (2 - 2x6mm)	2- 12MM (2 - 2x6mm)	4- 12MM (4 - 2X6MM)	2- 6MM (2 - 1x6mm)	YES
GREAT WALL 2010...ON	195mm from tail gate	2- 12MM (2 - 2x6mm)	2- 12MM (2 - 2x6mm)	4- 12MM (4 - 2X6MM)	2- 6MM (2 - 1x6mm)	YES
MITSUBISHI TRITON MN: 10/09...ON	250mm from tail gate	2- 15MM (2 -1x10mm 1x5mm)	2- 15MM (2 -1x10mm 1x5mm)	4- 5MM (4 - 1x5mm)	4- 5MM (4 - 1x5mm)	YES
MITSUBISHI TRITON ML: 8/06 - 9/09	220mm from tail gate	2- 15MM (2 -1x10mm 1x5mm)	2- 15MM (2 -1x10mm 1x5mm)	4- 10MM (4 - 1x10mm)	2- 6MM (2 - 1x6mm)	YES
MITSUBISHI TRITON MK: 10/96 - 07/06	250mm from tail gate	2- 15MM (2 -1x10mm 1x5mm)	2- 15MM (2 -1x10mm 1x5mm)	4- 5MM (4 - 1x5mm)	4- 5MM (4 - 1x5mm)	YES
FORD RANGER: 2006...ON	265mm from tail gate	2- 12MM (2 - 2x6mm)	2- 12MM (2 - 2x6mm)	4- 12MM (4 - 2X6MM)	2- 6MM (2 - 1x6mm)	YES
MAZDA BT-50: 2007...ON	265mm from tail gate	2- 12MM (2 - 2x6mm)	2- 12MM (2 - 2x6mm)	4- 12MM (4 - 2X6MM)	2- 6MM (2 - 1x6mm)	YES
MAZDA/ COURIER B2600: 1999- 2007	265mm from tail gate	2- 12MM (2 - 2x6mm)	2- 12MM (2 - 2x6mm)	4- 12MM (4 - 2X6MM)	2- 6MM (2 - 1x6mm)	YES
LANDCRUISER TROOP CARRIER 1985...ON	SEE INSTRUCTIONS SECTION 4	2- 15MM (2 -1x10mm 1x5mm)	2- 15MM (2 -1x10mm 1x5mm)	4- 10MM (4 - 1x10mm)	2- 6MM (2 - 1x6mm)	YES
<b>1045 SERIES:</b>						
200 SERIES LANDCRUISER	SEE INSTRUCTIONS SECTION 5	2- 30MM (3x10mm)	2- 20MM (2x10mm)	4- 15MM (4- 1x10mm) (4- 1x5mm)	N/A	YES
100 SERIES LANDCRUISER	SEE INSTRUCTIONS SECTION 5	2- 15MM (2- 1x10mm) (2- 1x5mm)	2- 20MM (2x10mm)	N/A	N/A	YES
80 SERIES LANDCRUISER GXL	SEE INSTRUCTIONS SECTION 5	2- 15MM (2- 1x10mm) (2- 1x5mm)	2- 15MM (2- 1x10mm) (2- 1x5mm)	N/A	N/A	YES
80 SERIES LANDCRUISER GXL	SEE INSTRUCTIONS SECTION 5	2- 10MM (2- 1x10mm)	2- 15MM (2- 1x10mm) (2- 1x5mm)	N/A	N/A	YES
NISSAN PATROL GU	SEE INSTRUCTIONS SECTION 5	2- 20MM (2x10mm)	2- 24MM: (2- 3x6mm)	4- 10mm (4x10mm)	2- 15MM (1x10mm) (1x5mm)	YES
<b>945 SERIES:</b>						
76 SERIES LANDCRUISER WAGON	SEE INSTRUCTIONS SECTION 6	2- 20MM (2 - 2x10mm)	2- 20MM (2 - 2x10mm)	4- 20MM (4 - 2x10mm)	2- 24MM (2 - 4x6mm)	YES
PRADO 120- 05- 11/09	SEE INSTRUCTIONS SECTION 6	2- 25MM (2 - 2x10mm) (2 - 1x5mm)	2- 30MM (2 - 3x10mm)	4- 20MM (4 - 2x10mm)	2- 12MM (2 - 2x6mm)	NO
FOR VEHICLES NOT LISTED AT TIME OF PRINT SEE "NEW INSTRUCTIONS" ENCLOSED SEPARATELY						

## SECTION 4. 1355 SERIES INSTALLATION INSTRUCTIONS:

75/ 78 SERIES LANDCRUISER TROOP CARRIER: 06/85...on.

TOYTA HILUX: 11/97 - 2004.

TOYOTA HILUX: 02/05...on.

NISSAN NAVARA D22: 04/97 - 10/05.

NISSAN NAVARA D40-STX & RX: 11/05...on.

MITSUBISHI TRITON MK: 10/96 - 07/06.

MITSUBISHI TRITON ML: 8/06 - 9/09.

MITSUBISHI TRITON MN: 10/09...on.

HOLDEN RODEO: 1988 - 11/02.

HOLDEN COLORADO: 12/02...on.

ISUSU RODEO: 12/02...on.





ISUSU D-MAX 2009...on.



GREAT WALL 2009...on.

MAZDA/ COURIER B2600: 1999- 2007.

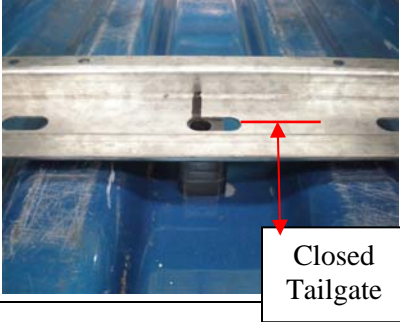
MAZDA BT-50: 2007...on.

FORD RANGER: 2006...on

<p>27.  Ensure steps 5–26 have been carried out. Read steps 28 to 35 prior to continuing.</p>	
<p>28. Have someone help lift frame into rear of vehicle on an angle taking care not to damage/scratch interior trim or paint work.</p>	
<p>29. Position frame laterally in vehicle. Measure from centre of the 10mm elongated mounting holes in <b>rear</b> hat section to the <b>metal</b> part of tailgate whilst tailgate is closed. Refer <b>Section 3...Spacer Thicknesses and Sizes</b> for vehicle specific measurements.</p> <p> Note: <u>Measurement allowance must be taken into consideration if vehicle has Tail Gate Liner.</u></p>	
<p>30. Place 4 assembled spacer blocks <b>central</b> of floor ribs in vehicle floor under marked holes on Hat Sections A and B; Refer <b>Section 3...Spacer Thicknesses and Sizes</b> for vehicle specific spacer sizes. Position marked holes on hat sections <b>central</b> to holes in spacer blocks; refer part 26 section.</p>	
<p>31. Position frame centrally in vehicle:</p> <p> <b>Dual units;</b> Place a steel ruler down between centre bearing channels and measure equally from sides of vehicle to <b>outside edge</b> of steel ruler.</p> <p><b>Single unit;</b> Place a steel ruler vertically up outside of centre bearing channel and measure equally from sides of vehicle to <b>outside edge</b> of steel ruler.</p>	

 <p>32. Check all measurements <b>toughly</b> and ensure all clear underneath vehicle before marking or drilling any holes. Roll drawer in, close tailgate and check for clearance of Slam Latch handle. Extract drawer.</p>	
<p>33. With the frame in correct position use a marking pen to mark drill holes on floor of vehicle; mark through spacer blocks placed <b>central</b> of floor ribs under hat sections A and B onto floor of vehicle.</p>	
<p>34. Move frame out towards <b>rear</b> of vehicle for access to marked drill holes. Place spacer blocks aside and using a 4mm drill bit drill a pilot hole through each of the four marked holes on floor of vehicle then follow through with a 6mm and 10mm drill.</p>	
<p>35. Move frame back into vehicle, place marked holes in hat section over drilled holes in vehicle floor and place spacer blocks back under hat sections A and B. Check frame is <b>central</b> in vehicle. See part 31 this section. Fasten frame to floor of vehicle using four (4) 10mm x 60mm bolts and washers with weatherproof plates and nyloc nuts underneath.</p>  <p>Ensure rear spacer blocks are in correct positions under each rear corner of the module and under the latch plate from erlier steps. See steps 24 and 25.</p>	

**Vehicle Specific Instructions 75 SERIES LANDCRUISER TROOP CARRIER: 06/85...on Drilling of holes required.**

Remove the rear metal mat protector strip and lift back about 300mm of floor mat. There are two rubber grommets in the floor about 900mm apart and about 250mm towards the front. Remove the grommets, replace the mat and poke a screwdriver through the mat down through the holes.

Have someone help lift framework into rear of vehicle and place on top of floor mat  
 Note: Lift and place in position carefully taking care not scratch or damage interior trim

Place marked holes in Hat Section B over the two (2) holes that you have made in the mat, push two (2) 10mm x 60mm bolts through the holes to keep frame in position. Position the frame centrally in vehicle. Check all measurements **toughly** and ensure all clear underneath vehicle before drilling any holes  
 Stand on Hat Section A and using a 10mm drill bit drill straight down through the centre of the two (2) marked holes in A. (a bit of underfelt will wind up on the drill bit when you have drilled through. With the drill stopped, a stiff pull will get it out). Remove the two (2) 10mm bolts holding B.

Place the four (4) assembled 15mm spacers lengthways on top of mat and under marked holes in A and B. **Loosely** bolt A and B down using four (4) 10mm x 60mm bolts, spring washers, two 10mm x 75mm x 40mm flat oblong washers and weather proof plates with nyloc nuts under vehicle.

Push frame to **front** of vehicle as far as possible. Check frame **central** in vehicle. See part 31 this section.  
**Now** Tighten all Bolts.

## SECTION 5. 1045 SERIES INSTALLATION INSTRUCTIONS:





200 SERIES LANDCRUISER 12/07...0N.

100 SERIES LANDCRUISER 04/98...11/07

80 SERIES LANDCRUISER... 01/95 - 03/98

NISSAN PATROL GU 11/97...on

**READ AND UNDERSTAND ALL INSTRUCTIONS BEFORE INSTALLING IN VEHICLE.**

<p>36.  Ensure steps 5–27 have been carried out. Read and follow steps 37 to 43 and Vehicle Specific Instructions in this section prior to continuing.</p>	
<p>37. Have someone help lift frame into rear of vehicle on an angle taking care not to damage/scratch interior trim or paint work, place frame in vehicle over vacant bolt holes or to given measurements;</p> <p> Refer <b>Section 3...Spacer Thicknesses and Sizes</b> for vehicle specific measurements.</p>	
<p>38. Position frame centrally in vehicle:</p> <p> <b>Dual units;</b> Place a steel ruler down between centre bearing channels and measure equally from sides of vehicle to <b>outside edge</b> of steel ruler.</p> <p><b>Single unit;</b> Place a steel ruler vertically up outside of centre bearing channel and measure equally from sides of vehicle to <b>outside edge</b> of steel ruler.</p>	
<p>39. If installing a Roller Floor module, roll floor out to fully extended position. Rolling floor out to full extension provides access for fixing, marking and drilling locations.</p> <p> <b>Drilling of holes if required:</b> Refer following Vehicle Specific Instructions. <u>Check all measurements toughly and ensure all clear underneath vehicle before marking or drilling any holes.</u></p>	
<p>40. With the frame in correct position use a marking pen to mark drilling locations onto floor of vehicle. Mark through spacer blocks placed under marked holes in hat sections A and B onto floor of vehicle. See part 26 Section.</p>	
<p>41. Move frame out towards <b>rear</b> of vehicle for access to marked drill holes. Place spacer blocks aside and using a 4mm drill bit drill a pilot hole through each of the marked holes on floor of vehicle then follow through with a 10mm drill bit.</p>	

<p>42. Move frame back into vehicle, place marked holes in Hat Sections over drilled holes, place spacer blocks back under hat sections A and B. Refer <b>Section 3...Spacer Thicknesses and Sizes</b> for vehicle specific spacer sizes. Fasten frame to floor of vehicle using bolts, spring washers, flat washers and weatherproof plates with nyloc nuts underneath vehicle.</p>	
<p>43. Position frame centrally in vehicle:  <u>Dual units</u>; Place a steel ruler down between centre bearing channels and measure equally from sides of vehicle to <b>outside edge</b> of steel ruler.  <u>Single unit</u>; Place a steel ruler vertically up outside of centre bearing channel and measure equally from sides of vehicle to <b>outside edge</b> of steel ruler.</p>	
<p>44. Place 4 assembled spacer blocks <b>central</b> of floor ribs in vehicle floor under marked holes on Hat Sections A and B; Refer <b>Section 3...Spacer Thicknesses and Sizes</b> for vehicle specific spacer sizes. Position marked holes on hat sections <b>central</b> to holes in spacer blocks; refer part 27 section 1 of General Instructions.</p>	
<p><b>Vehicle Specific Instructions: 200 SERIES LANDCRUISER 12/07...on</b></p> <p>Remove Dickie Seats from Vehicle four bolts per seat.  Return six bolts to vacant holes leaving two exposed holes, 1018mm apart and 250mm in from the rear plastic trim edge.  Prise off two plastic cups and unbolt dickie seat lock down bars from forward position only.  Return Inner bolts to holes leaving 2 exposed holes 592mm apart and 720mm in from rear plastic trim edge.  Cut Floor Mat and fold back cut part back under mat to accommodate Plastic Packers.</p> <p><b>Frame Installation:</b>  Have someone help lift framework into rear of vehicle on an angle and place in position over vacant boltholes in floor. <b>Note:</b> <u>Lift and place in position carefully, take care not to scratch or damage interior trim.</u></p> <p>Using the spacers put aside place spacers <u>lengthways</u> under hat sections of frame over the four vacant bolt holes in floor of the vehicle. Place the two 30mm spacers under <b>front</b> hat section A and place the two 20mm spacers under <b>rear</b> hat section B</p> <p><u>Loosely</u> bolt <b>front</b> hat section A down using two the 10mm x 60mm bolts, spring washers and two 10mm x 75mm x 40mm flat oblong washers. <u>Loosely</u> bolt <b>rear</b> hat section down using the two 10mm x 50mm bolts, spring washers and two 10mm x 75mm x 40mm flat oblong washers.  <b>NOTE: See step 26 for placing spacers under marked holes in Hat Sections:</b></p> <p>Position frame centrally in vehicle and tighten all bolts</p>	

**Vehicle Specific Instructions: 100 SERIES LANDCRUISER 04/98...11/07**

**Drilling of holes required: Standard 5- seat models.**

RV and GXL Models: Remove plastic covers and locking plates for rear dickie seats from under mat or carpet. Replace the four (4) bolts closest to centre of the vehicle leaving the four (4) outer holes 570mm apart vacant. Cut mat and fold back "ears" to expose vacant bolt holes. Remove rear seat belts and plastic covers from mounts next to wheel arches. Replace seat belt bolts.

Standard Models: Fold rear floor mat back and measure forward 745mm from front edge of carpet protector strip. Pull back mat at this point and remove two rubber bungs from two holes closest to wheel arches (570mm apart).

Remove rear tie downs from under mat or carpet then cut mat and fold back cut part back under mat to expose vacant bolt holes. Remove child restraint cover and replace bolt.

**Frame Installation:**

Have someone help lift framework into rear of vehicle on an angle and place in position over vacant boltholes in floor. Note: Lift and place in position carefully, take care not to scratch or damage interior trim.

GXL Models Using the spacers put aside place spacers lengthways on the vehicle floor underneath each of the marked holes in Hat Sections A and B, place the 15mm spacers under A and 20mm spacers under B. Bolt down A and B using four (4) 10mm x 40mm metric fine bolts, spring washers and 45mm x 75mm flat washers. Bolt down B using the two (2) 6mm x 50mm bolts, spring washers and 45mm x 75mm flat washers.

**NOTE: See part 26 for placing spacers under marked holes in Hat Sections.**

Standard Models: Using the spacers put aside place the two (2) 15mm spacers lengthways on the vehicle floor underneath each of the marked holes in Hat Section A and loosely bolt down A using two (2) 10mm x 40mm bolts, spring and 10mm x 75mm x 40mm flat oblong washers

Check all clear underneath vehicle floor first before drilling any holes then use a 10mm drill bit and drill straight down through the two (2) marked holes in Hat Section B. Using the spacers put aside place the two (2) 20mm spacers under marked holes in Hat Section B and bolt down using two (2) 10mm x 50mm bolts and 10mm x 75mm x 40mm flat oblong washers with weatherproof plates and nyloc nuts underneath. NB: These holes must be drilled and bolts installed to comply with ADR 42/03.

**NOTE: See part 26 for placing spacers under marked holes in Hat Sections.**

Position frame centrally in vehicle and tighten all bolts.

**Vehicle Specific Instructions: 80 SERIES LANDCRUISER... 01/95 - 03/98**

**Drilling of holes required: Standard 5- seat models**

Remove seat belts from rear cargo area if fitted.

**GXL-7 seat models only:** Remove front most locking plates for the rear dickie seats from under the mat or carpet. Replace the two bolts closest to the centre of the vehicle approximately 570mm apart.

**GXL-7 seat and Standard-5 seat models:**

Remove rear tie-downs from under the mat or carpet. Replace the two (2) rear most tie-down bolts and cut small squares out of the mat to expose the two (2) vacant boltholes. **Drill vacant tie down bolt holes out to 10mm; this must be done to comply with ADR42/03**

**Frame Installation:**

Have someone help lift framework into rear of vehicle on an angle and place in position over vacant boltholes in floor. **Note:** Lift and place in position carefully, take care not to scratch or damage interior trim.

**GXL-7 seat models:** Using the 15mm spacers put aside place spacers lengthways on the vehicle floor underneath each of the marked holes in Hat Sections A and B. Loosely bolt down Hat Section A using the two (2) 10mm x 35mm bolts, spring washers and 10mm x 75mm x 40mm flat oblong washers. Loosely Bolt down B using the two (2) 10mm x 50mm bolts, spring washers, 10mm x 75mm x 40mm flat oblong washers with weatherproof plates and nyloc nuts underneath. Position frame centrally in vehicle and tighten all bolts.

**Standard-5 seat models:** Using the spacers put aside place the two (2) 15mm plastic spacers lengthways on the vehicle floor underneath the marked holes in Hat Section B and loosely bolt down into drilled out tie down bolt holes using the two (2) 10mm x 50mm bolts and flat washers with weatherproof plates and nyloc nuts underneath.

Position frame centrally in vehicle and using a 10mm drill down through the centre of the two (2) marked holes in Hat Section A. Place the two (2) 10mm plastic spacers lengthways beneath the holes in A and bolt down using the two (2) 10mm x 50mm bolts and 10mm x 75mm x 40mm flat oblong washers with weatherproof plates and nyloc nuts underneath. Now tighten all bolts.

**NOTE:** See part 26 for placing spacers under marked holes in Hat Sections.

**Vehicle Specific Instructions: NISSAN PATROL GU 11/97...on****Drilling of holes required.**

Remove seat belts. To remove seat belts fitted in rear cargo area undo bottom seat belt fittings from wheel arches and replace bolts and washers. Remove plastic seat belt surround cover from top trim panels and pull seat belt through cover. Wrap tape around seat belt fittings; feed down inside of trim panels and replace plastic covers.

Remove child restraint bolts. Remove the two (2) **front** luggage tie downs and replace all bolts. Remove the right hand **rear** luggage tie down, replace front most bolt. Check all clear underneath vehicle floor first before drilling any holes. Drill the vacant right hand tie down hole out to 12mm.

**Standard RX & DX Models:** Remove two (2) foam spacer pads from under middle of floor mat.

Measure forward into vehicle from **rear** edge of door opening approximately 860mm peel back the mat or carpet at this point so as to expose two (2) boltholes 860mm apart. Remove bolts or grommets if fitted. Using a sharp trim knife make oblong three sided cuts lengthways in mat or carpet, fold oblongs back under mat or carpet so as to expose the two (2) vacant holes and enable spacer blocks to sit directly onto vehicle floor.

**Frame Installation:**

Have someone help lift framework into rear of vehicle on an angle and place the two (2) marked holes in Hat Section A over vacant boltholes in floor. **Note:** Lift and place in position carefully, take care not to scratch or damage interior trim.

Place two (2) 20mm spacers lengthways between the floor and the frame underneath each of the marked holes in Hat Section A. Loosely bolt down A into vacant bolt holes using two (2) 5/16" x 2" bolts, spring washers, large 8mm flat washers and 10mm x 75mm x 45mm oblong washers. Push frame to rear of vehicle as far as it will go and firmly fasten the two (2) 5/16 bolts hold frame in position (removal is required later during installation).

Place one (1) 24mm plastic spacer lengthways between the floor and the frame underneath the marked right hand hole in Hat Section B. Drop one (1) 10mm bolt through marked hole to hold frame in position

Check all clear underneath vehicle floor first before drilling any holes.

Using a marking pen mark through centre of left hand marked hole in hat Section B onto mat or carpet. Remove bolts holding frame, move frame out towards rear of vehicle leaving spacer blocks in position. Using a sharp trim knife make an oblong three sided cut lengthways where marked on mat or carpet, fold oblong back under mat or carpet to enable spacer block to sit directly onto vehicle floor.

Move frame back into position over spacer blocks. Place one (1) 24mm spacer block under marked hole on left hand side of Hat Section B. Loosely bolt down A into vacant bolt holes using two (2) 5/16" x 2" bolts, 8mm flat washers, spring washers and 10mm x 75mm x 45mm oblong washers

Loosely bolt down Hat Section B using two (2) 10mm bolts, spring washers, 10mm x 75mm x 45mm oblong washers and weatherproof plates, nyloc nuts under vehicle floor

Push frame to **front** of vehicle as far as possible. Check frame central in vehicle. See part 38 this section.





**Now** Tighten all Bolts

## SECTION 6. 945 SERIES INSTALLATION INSTRUCTIONS:

76SERIES LANDCRUISER WAGON.

TOYOTA LANDCRUISER PRADO 120 1/05 TO 10/09

**READ AND UNDERSTAND ALL INSTRUCTIONS BEFORE INSTALLING IN VEHICLE.**

<p>45.  Ensure steps 5–27 have been carried out. Read and follow steps 47 to 58 and Vehicle Specific Instructions in this section prior to continuing.</p>	
<p>46. Have someone help lift frame into rear of vehicle on an angle taking care not to damage/scratch interior trim or paint work, place frame in vehicle over vacant bolt holes or to given measurements;</p> <p> Refer <b>Section 3...Spacer Thicknesses and Sizes for vehicle specific measurements.</b></p>	
<p>47. Position frame centrally in vehicle:</p> <p> <b>Dual units;</b> Place a steel ruler down between centre bearing channels and measure equally from sides of vehicle to <b>outside edge</b> of steel ruler.</p> <p><b>Single unit;</b> Place a steel ruler vertically up outside of centre bearing channel and measure equally from sides of vehicle to <b>outside edge</b> of steel ruler.</p>	
<p>48. If installing a Roller Floor module, roll floor out to fully extended position. Rolling floor out to full extension provides access for fixing, marking and drilling locations.</p> <p> <b>Drilling of holes if required:</b> Refer following Vehicle Specific Instructions. <u>Check all measurements</u> <b>toughly and ensure all clear underneath vehicle before</b></p>	



<u>marking or drilling any holes.</u>	
49. With the frame in correct position, use a marking pen to mark drilling locations onto floor of vehicle. Mark through spacer blocks placed under marked holes in hat sections A and B onto floor of vehicle. See part 26 Section.	
50. Move frame out towards <b>rear</b> of vehicle for access to marked drill holes. Place spacer blocks aside and using a 4mm drill bit drill a pilot hole through each of the marked holes on floor of vehicle then follow through with a 12mm drill bit.	
51. Move frame back into vehicle, place marked holes in Hat Sections over drilled holes, place spacer blocks back under hat sections A and B. Refer <b>Section 3...Spacer Thicknesses and Sizes</b> for vehicle specific spacer sizes. Fasten frame to floor of vehicle using bolts, spring washers, flat washers and weatherproof plates with nyloc nuts underneath vehicle.	
<p><b>Vehicle Specific Instructions: 76 SERIES LANDCRUISER WAGON</b></p> <p><b><u>Drilling of holes required.</u></b></p> <p><b>Frame Installation:</b> Have someone help lift framework into rear of vehicle and place on top floor mat. <b>Note:</b> <u>Lift and place in position carefully, take care not to scratch or damage interior trim.</u></p> <p>With <b>rear</b> door shut position frame laterally in vehicle by measuring 198mm from centre of marked holes in Hat Section B to <u>metal</u> part of door. Position frame centrally in vehicle. See part 43 this section</p> <p><i>Check all measurements toughly and ensure all clear underneath vehicle before drilling any holes</i> Stand on Hat Section A and using a 10mm drill bit drill straight down through the centre of the two (2) marked holes in A. (a bit of underfelt will wind up on the drill bit when you have drilled through. With the drill stopped, a stiff pull will get it out) Push two (2) 10mm bolts through drilled holes to help keep frame in position. Stand on Hat Section B and using a 10mm drill bit drill straight down through the centre of the two (2) marked holes in B. Remove the two (2) 10mm bolts in Hat Section A helping keep frame in position</p> <p>Place the four (4) 20mm spacers <u>lengthways</u> on top of mat and under marked holes in A and B.</p> <p><b>Loosely</b> bolt A and B down using four (4) 10mm x 60mm bolts, spring washers, two 10mm x 75mm x 40mm flat oblong washers and weather proof plates with nyloc nuts under vehicle.</p> <p>Push frame to <b>front</b> of vehicle as far as possible. Check frame <u>central</u> in vehicle. See part 47 this section. <b>Now</b> Tighten all Bolts.</p>	
<p><b>Vehicle Specific Instructions: TOYOTA LANDCRUISER PRADO 120.... 1/05 TO 10/09</b></p> <p>Remove Dickie seats. If seats already removed remove plastic seat lock covers</p> <p>Remove plastic covers and locking plates for rear dickie seats and remove eight (8) bolts. Replace the four (4) bolts closest to centre of the vehicle leaving four (4) outer holes 490mm apart vacant. Cut slits in mat and fold “ears” back underneath so vacant bolt holes are exposed and plastic spacer blocks supplied can sit flat on metal floor.</p> <p>Have someone help lift framework into rear of vehicle <b>Note:</b> <u>Lift and place in position carefully, take care not to scratch or damage interior trim.</u> Line up the two (2) marked holes in A and B hat sections with the</p>	

four (4) vacant boltholes for locking plates.

Place the two (2) 25mm spacers lengthways between the floor and the frame underneath the marked holes in Hat Section A and the two (2) 30mm spacer under marked holes in Hat Section B



**NOTE: See part 30 for placing spacers under marked holes in Hat Sections**

**Loosely** bolt down Hat Sections A and B using four (4) 10mm x 50mm **metric fine** bolts.

Check frame central in vehicle and push frame to **front** of vehicle as far as possible. **Now tighten all bolts.**

## SECTION 7. Assembly and Finishing Off.

**READ AND UNDERSTAND ALL INSTRUCTIONS BEFORE INSTALLING IN VEHICLE.**

<p>52. <b>SIDE FLOOR KIT.</b> If fitting a side floor kit, this should be done now.</p>	<p>Use instructions supplied with floor kit.</p>
<p>53. <b>DRAWER REPLACEMENT.</b> Roll drawers in past the second top bearing and bolt Drawer Stops back on using original 6mm bolts. Ensure 6mm flat washers are still under bolt heads. Note orientation of drawer stops “arm” faces <b>rear</b> of vehicle and nylock nuts inserted in drawer stops face <b>outwards</b> away from drawer body to engage 6mm bolts.</p> <p> Photo shows drawer stop fitted in correct orientation. Frame has been removed for clarity. Stop must be fitted while drawer is in the frame.</p>	
<p>54. <b>FIXED FLOOR REPLACEMENT.</b> Using a 4mm hexagon head Allen key fasten floor back in position using original countersunk set screws.</p>	
<p>55. Remove all tools from the vehicle, ensuring none are left under or inside the drawer or roller floors. Dust off drawers and ensure any swarf from drilling has been removed.</p>	

## SECTION 8. Stacker Drawer installation.

**READ AND UNDERSTAND ALL INSTRUCTIONS BEFORE INSTALLING IN VEHICLE**

58. Remove Fixed Floor from parent drawer.



Section one Step 5 in section one covers fixed floor removal.



59. If required, fit the carpeted fill in floor piece to the **front** of the parent frame, behind the shorter Stacker Drawer.

60. Fasten the two (2) 20 mm round spacers with round head bolts inserted into the cavity into captive nuts in the rear of the parent frame. Flat surface of spacers sit on top of captive nut in parent frame.



Ensure spacers used on this step are the ones with round head bolts inserted into the cavity and not the vacant 20mm round spacers to be used on step 63.



61. Remove Fixed Floor and Roller Drawer/ Tray from Stacker module frame. Remove the two bottom Hat Mounts from Stacker module frame and put aside. Hat mounts are not required in Stacker Drawer/ module to parent drawer installation.



See section one step 5 for fixed floor removal.  
Section one step 7 covers drawer removal.  
Roller floors should be opened and not removed.

62. Remove the parent spacers from underside corners of Stacker Drawer framework. Parent Spacers are not required for Stacker Drawer to Parent Drawer installation.





63. Place 20mm round spacers over captive nuts inserted in top of parent frame, heads of captive nuts sit into recess in spacers.



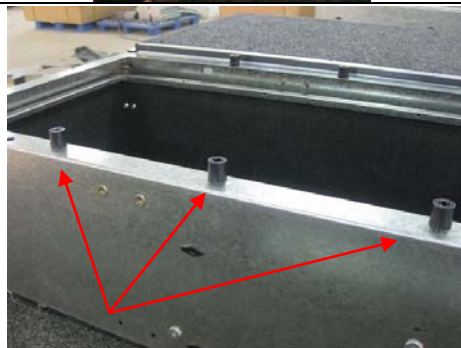

Spacers in this step are the vacant spacers not the ones with bolts inserted as used in step 60.



<p>64. Fasten Stacker module frame to Parent Frame using 6mm x 30mm <u>hexagon</u> head bolts and spring washers. Fasten through Stacker Drawer frame, 20mm round spacers and into captive nuts in Parent Frame.</p>	
<p>65. <b>Reinstall Roller Drawer into Stacker Drawer.</b> Roll drawers in past the second top bearing and bolt Drawer Stops back on using original 6mm blots. Ensure 6mm flat washers are still under bolt heads. Note orientation of drawer stops “arm” faces <b>rear</b> of vehicle and nylock nuts inserted in drawer stops face <b>outwards</b> away from drawer body to engage 6mm bolts. See step 53.</p>	
<p>66. <b>Reinstall Fixed Floor onto Stacker Drawer.</b> Using a 4mm hexagon head Allen key fasten floor back in position using original countersunk set screws.</p>	

## SECTION 9. Single and Custom Installation.

<p>67. <b><u>Single Module Installation:</u></b> Modules must be fastened down using four (4) 10mm bolts.</p> <p>68. <b><u>Multiple Module Installation:</u></b> In multiple module installation, four or more fixing bolts are spread across all modules. That is two in each module.</p> <p>The installer is responsible for selecting four or more suitable locations for the mounting bolts.</p> <p>If required the hat sections can be relocated. See section 1step 13.</p> <p> <b>The installer may also have to adjust the thickness of the spacers to ensure the frame is properly supported, clear of the floor and clears any structural framework.</b></p> <p>Spacers should be used on both rear corners of the module (<b>step 23</b>), under the slam latch catch (<b>step 24</b>) and under each bolt location (<b>step 26</b>).</p> <p> Care must be taken in selecting the fixing positions. <u>Ensure all clear underneath before drilling any holes.</u> Be wary of fuel tanks, fuel lines, electrical wires, Chassis and other under vehicle components.</p>	
--	--

**Fastening Stacker Drawer to vehicle floor:  
(Cab Chassis configurations)**

Leave Hat Mount sections attached to Stacker Drawer frame, move as required to select suitable fixing positions see step 66 [Single Module Installation](#) and step 67 [Multiple Module Installation](#)

Clip spacer blocks to parent spacer located on **rear** underside corners of Stacker Drawer frame. Clip enough spacers together to form a suitable height allowing drawer to roll out and clear any of the trays structural framework.



## SECTION 10. Fasten two roller floors together



At **rear insides** of floor runners there is a blank 6.2mm hole in metal frame, run a 6.2mm drill bit through this hole through to outside of aluminium trim  
Drill same hole out in opposing Roller Floor. De-burr the two holes made in aluminium trims

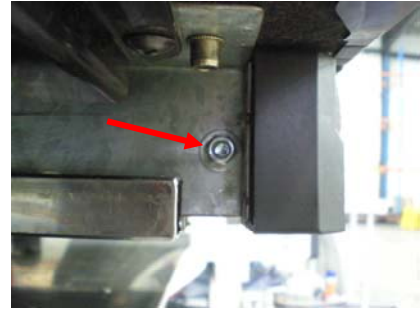

Fasten floors together by rolling one floor passed the other.  
Push bolt partially through first hole.  
Place three (3) M6 flat washers together over bolt threads.  
Pull floors apart slightly, roll other floor back passed bolt enabling bolt to pass through second hole.  
Fasten floors together using M6x20 hex head bolt with flat washers under head of **bolt**, **Nyloc nut** and tighten.

